

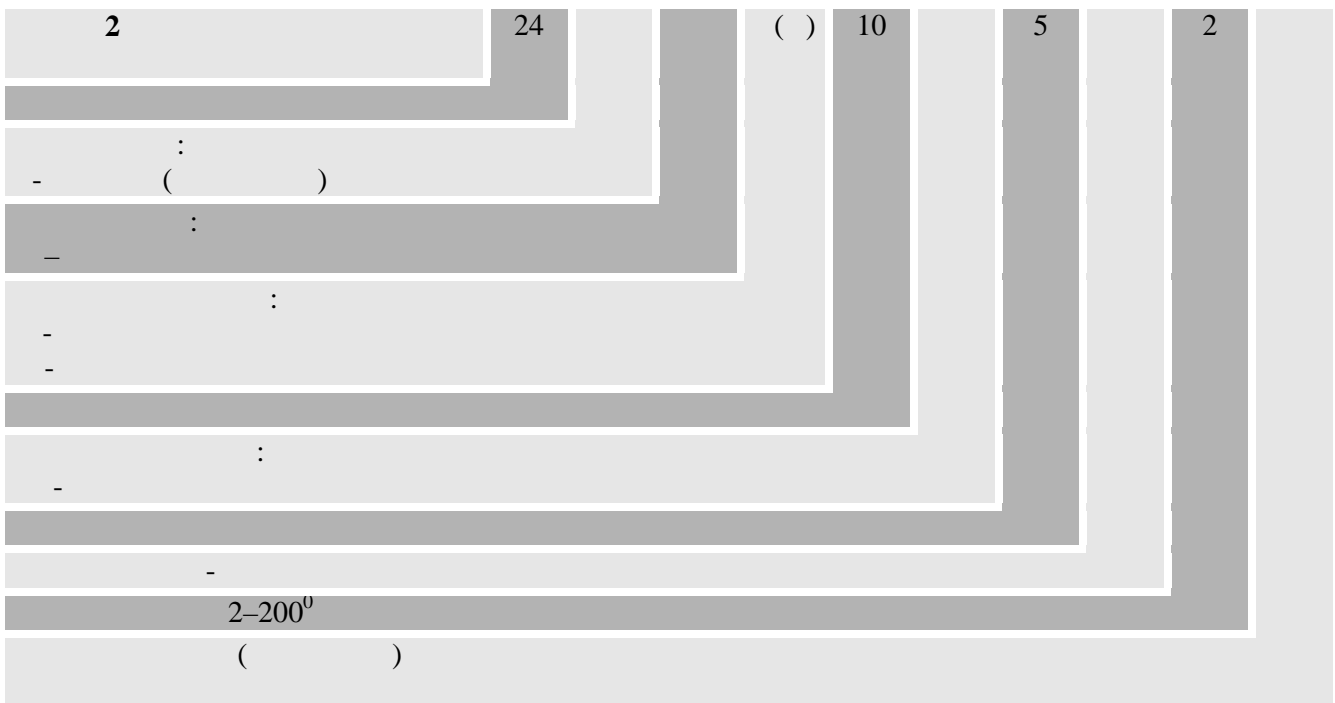

2 , 2

() 2 , 2 (2 3) ()
 2 . 2 - 2 ,
 .364.126 .
 , - Ø1,0; 1,5; 2,0 3,0
 .2.

.364.140 .



" "

2 14 4 1 2 .364.140 ,
 2 22 4 3 2 .364.140 ,

2 18 4 5 2 : .364.140 .

1

	1	1,5	2	3
	15	10	5	3















, , 5000
 . .2
 (147099,8 (1,5 / ²) . .2
 – 500
 , 200⁰ : 1000
 , 25











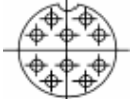

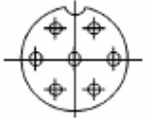

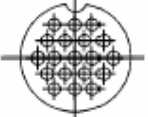

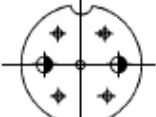

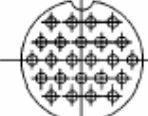

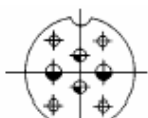

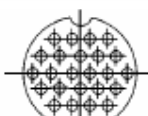

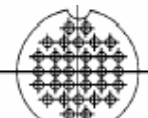

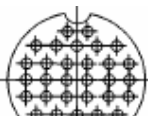

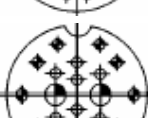

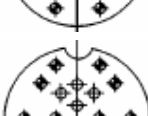
: , / ² (g) 5-5000 500 (50)		, ⁰ 200 , ⁰ 60
: , / ² (g) 5000 (500)		, (. .) 1,34 10 ⁻¹⁰ (10 ⁻¹²)
: , / ² (g) 1000 (100)		





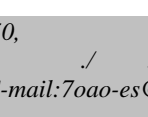





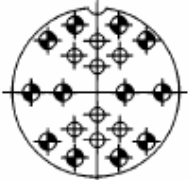

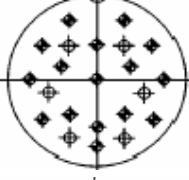

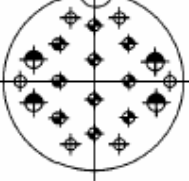

200 ⁰ ,	, ⁰
1000	250
2000	240
3000	230
4000	225
5000	220
25000	200
50000	190
100000	180

%,	, ⁰
120	80
110	60
100	50
85	40
75	30
60	25
50	20

2

1	2	3	4	5	6	7	8	9	10
14	2			1	4	1	6	20	560
18	2			1,5	4	5	12	40	560
	2			1	7	1	5	30	560
22	2			2	2	3	13	55	560
				3			20		
24	2			1	10	1	5	42	560
				1	19	1	4	63	560

	2			1,5	10	5	8	48	560
27	2			1,5	7	5	9	52	700
				1,5	19	5	6	95	560
	2			1	5	2	6	45	700
				1,5	2		12		
30	2			1	24	1	4	80	560
				1,5	4	7	9	88	560
				2	2		12		
			3	2	20				
		1,5	24	5	5,5	110	560		
33	2			1	32	1	3	80	560
	2			1,5	32	5	5	133	560
				1	10	4	4	76	560
				3	8		4		700
		3	2	20	560				
36	2			1	8	1	4,5	75	560
					12		4,5		700
				1,5	8	6	8	120	560
					10		8		700
		3	2		20		560		

	2			1,5	8	5	7	116	560
			12					700	
				1	5	1	4,5	82	560
		17					700		
			1	6	2	4	80	560	
		10					700		
39	2			1,5	4		8		560
			6					560	
			1,5	16	5	7	128	700	
		30						560	
			1	10	2	3	125	700	
		5						560	

2 , 2

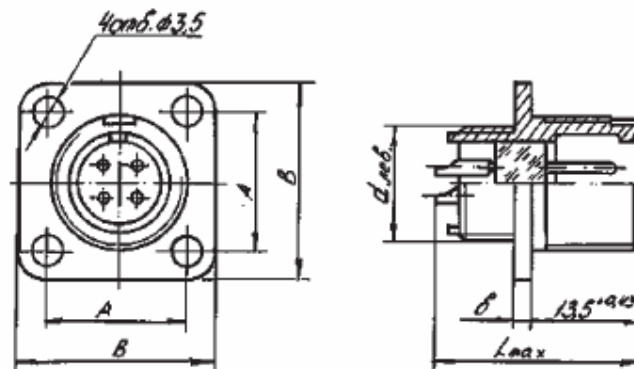

3

		d			b	L _{max}
14	2	14 1	17	24	1,8 7	26,5
18	2 , 2	18 1	20	27	2,5 7	26,5
22	2	22 1	23	30	1,8 7	28,5
24	2 , 2	24 1	26	33	2,5 7	26,5
27	2 , 2	27 1	29	36	2,5 7	26,5
30	2	30 1	31	38	2,5 7	26,5
33	2	33 1	32	40	1,8 7	28,5
33	2	33 1	32	40	1,8 7	26,5
39	2 , 2	39 1	37	46	1,8 7	26,5

4

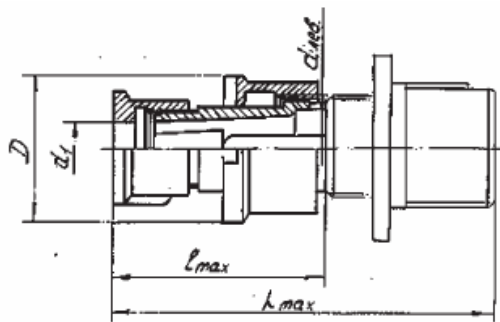

d	d ₁	D	l _{max}	L _{max}
14 1	6,5	19	28,7	48
18 1	10,5	22,5	28,7	48
22 1	14	27	28,7	48
24 1	16	29	34,7	54
27 1	18	32	34,7	54
30 1	19	36	34,7	54
33 1	23	39	39,7	59
36 1	23	42	39,7	59
39 1	24	45	39,7	59
42 1	29	48	39,7	59

5

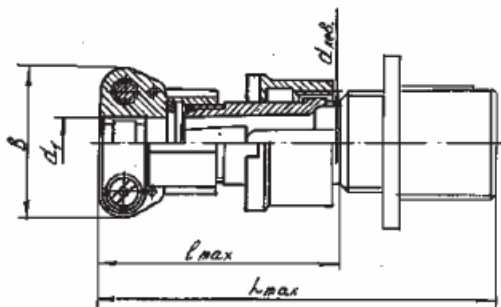

d	d ₁	D	l _{max}	L _{max}
14 1	6,5	21	34	53,5
18 1	10,5	25	34	53,5
22 1	14,5	32	36,5	55,5
24 1	16,6	34	43	55,5
27 1	18,5	36	43	62,5
30 1	20,5	38	43	62,5
33 1	22,5	41	48	67,5
36 1	22,5	41	48	67,5
39 1	24,5	44	48	67,5
42 1	30,5	50	48	67,5